

**CRUX**  
Hand Made Sinks



New  
Series

[www.kromeveye.com.tr](http://www.kromeveye.com.tr)



**KROMEVEYE**





# CRUX

Hand Made Sinks

In history all began with an interaction.  
Stainless steel was formed by the interaction of  
Iron and Chromium,

**interaction is the  
beginning**





**KROMEVEYE**

**KROMEVEYE... The real brand in sinks...**



Krom Evye Sanayi ve Ticaret A.S. was founded in 1979 in Istanbul by Mr. Ahmet SÜZGÜN and has been the leading company in stainless steel kitchen sinks with KROMEVEYE brand since its establishment.

KROMEVEYE, the pioneer of stainless steel sink production in Türkiye, has the largest and at the same time the most advanced stainless steel kitchen sink production line in Turkey.

Approximately 160 people work in the facilities located on an area of 23.000 m<sup>2</sup> and 16.500 m<sup>2</sup> closed area.



KROMEVEYE has a production capacity of 100.000 stainless steel sinks per month.



KROMEVEYE's production quality is registered with ISO 9001:2008, BSCI, CE, IAPMO, CSTB, TSE certificates.

Modelling studies and all molds of the stainless steel kitchen sinks we produce are designed by our R&D engineers in our factory and produced on CNC machines in our own mold shop.



For 45 years, the name of the kitchen sink has been engraved in the memories as KROMEVEYE by proving its quality with the use of millions of people in Türkiye. Not only that, KROMEVEYE continues to export KROMEVEYE products to nearly 40 countries including European countries such as France, Germany, Italy, Switzerland, England, Austria, Czechia and Hungary.



File Number: 16839

In addition, KROMEVEYE established factories in Egypt, Russia, Ukraine, Algeria and Morocco in order to meet the international demand and still continues its production with foreign partnerships.



Today, the second generation of the family continues the journey with innovations and breakthroughs that Mr. Ahmet SÜZGÜN started in 1979.

KROMEVEYE, which has been renewed altogether, now works with SAP-based planning, production, sales and finance management system.

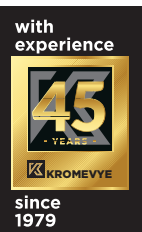

As the leader of the sector as it has been for 45 years, KROMEVEYE manufactures sinks produced with the latest automation systems as well as sinks that appeal to the upper group produced with precise hand workmanship.

**KROMEVEYE, Türkiye's leading brand ...**

**KROMEVEYE, Always the leader ...**



Sink factories in 4 countries



23.000 m<sup>2</sup> production facility

The kitchen sink is seen as the heart of the kitchen, let your imagination run free with a range of options to help maximise space and accentuate the look of the room.

**The following information will help to ensure that your ideal sink is the perfect fit for your kitchen.**

### Sink mounting options

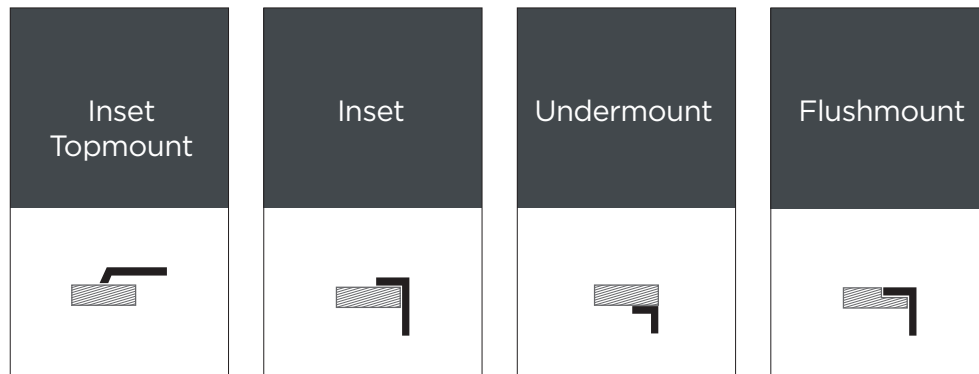

## IAPMO RESEARCH AND TESTING, INC.

5001 E. Philadelphia Street, Ontario, CA 91761 • Phone (909) 472-4100 • Fax (909) 472-4244 • www.iapmo.org



### CERTIFICATE OF LISTING



IAPMO Research and Testing, Inc. is a product certification body in which its product certification system includes inspection and testing of samples taken from the supplier's stock or from the market or a combination of both to verify compliance to the requirements of applicable codes and standards. This activity is coupled with periodic surveillance of the supplier's factory and/or warehouses as well as the assessment of the supplier's Quality Assurance System. This listing is subject to the conditions set forth in the characteristics below and is not to be construed as any recommendation, assurance or guarantee by IAPMO Research and Testing, Inc. of the product acceptance by Authorities Having Jurisdiction.

Issued To:

### KROM EVYE SAN. VE TIC. A. S.

AKCABURGAZ MAH. 117 SOK. NO. 19 ESENYURT ISTANBUL, Turkey

Product:

#### Plumbing Fixtures (Stainless Steel)

Products are in compliance with the following code(s):

Uniform Plumbing Code (UPC®)  
National Plumbing Code of Canada

Products are certified to the following standard(s):

ASME A112.19.3-2022/CSA B45.4-22

File Number: 16839

Effective Date: October 2024

Void After: October 2029\*

*Tom Collins*  
Chairman, Product Certification Committee



*SN 12*  
Chief Technical Service Officer

\*This certificate is not evidence of current listing. To verify listing status, visit the IAPMO R&T Product Listing Directory at [pl.iapmo.org](http://pl.iapmo.org)

This listing period is based upon the last date of the month indicated on the Effective Date and Void After Date shown above. Any change in material, manufacturing process, marking or design without having first obtained the approval of the Product Certification Committee, or any evidence of non-compliance with applicable codes and standards or of inferior workmanship, may be deemed sufficient cause for revocation of this listing. Production of or reference to this form for advertising purposes may be made only by specific written permission of IAPMO Research and Testing, Inc. Any alteration of this certificate could be grounds for revocation of this listing. This document shall be reproduced in its entirety.

Kromeveye sinks rank among the most durable sinks in the market since they are manufactured from 18/10 stainless steel up to 1 mm in thickness. The main advantage of thicker steel are greater impact resistance, increased stability of a sink tap and significantly reduced level of water splashing noise. In weight comparison, sinks made of thicker stainless steel are heavier.

Granite composite sinks are composed of granite parts tightly bound with high quality acrylic resin, which helps to acquire excellent mechanical properties and chemical persistence.

### Features

- Undercoated and Sound Pads
- Template and Mounting Clips
- Individual custom carton package or 3 per carton
- Customized Thickness & Depth



### H3103440R10



Flushmount    Inset    Undermount

Overall Size	380 x 440	380 x 440
Bowl Size	340 x 400	340 x 400
Sinks Depth	203	254
Thickness	1 mm	1 mm
Cabinet Size	400 mm	400 mm
Surface	Polished	Polished

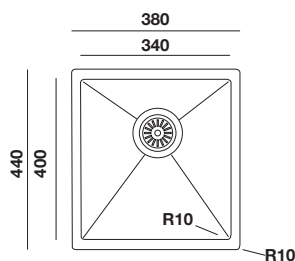

### H3103840R10

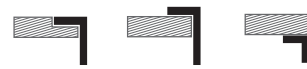

Flushmount    Inset    Undermount

Overall Size	420 x 440	420 x 440
Bowl Size	380 x 400	380 x 400
Sinks Depth	203	254
Thickness	1 mm	1 mm
Cabinet Size	400 mm	400 mm
Surface	Polished	Polished

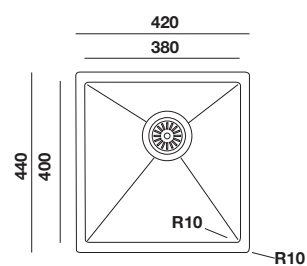

# New Series

# CRUX

## H3104040R10



Overall Size	440 x 440	440 x 440
Bowl Size	400 x 400	400 x 400
Sinks Depth	203	254
Thickness	1 mm	1 mm
Cabinet Size	450 mm	450 mm
Surface	Polished	Polished

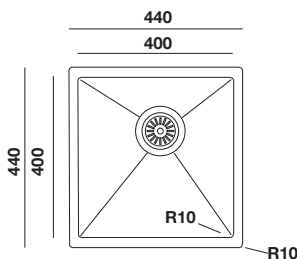

## H3104045R10



Overall Size	490 x 440	490 x 440
Bowl Size	450 x 400	450 x 400
Sinks Depth	203	254
Thickness	1 mm	1 mm
Cabinet Size	500 mm	500 mm
Surface	Polished	Polished

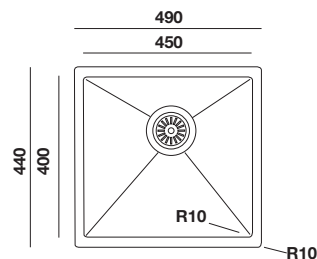





### H3104050R10



Overall Size	540 x 440	540 x 440
Bowl Size	500 x 400	500 x 400
Sinks Depth	203	254
Thickness	1 mm	1 mm
Cabinet Size	600 mm	600 mm
Surface	Polished	Polished

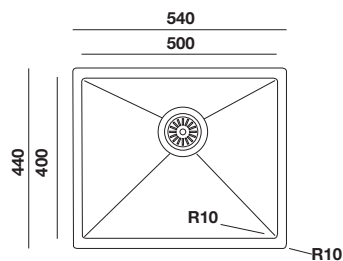

### H3104060R10

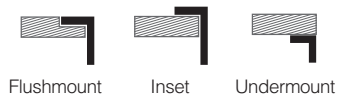

Overall Size	600 x 440	600 x 440
Bowl Size	550 x 400	550 x 400
Sinks Depth	203	254
Thickness	1 mm	1 mm
Cabinet Size	650 mm	650 mm
Surface	Polished	Polished

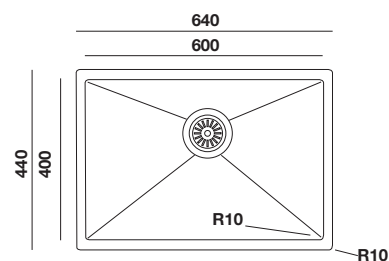

# New Series

# CRUX

**H3104070R10**

Overall Size	740 x 440	740 x 440
Bowl Size	700 x 400	700 x 400
Sinks Depth	203	254
Thickness	1 mm	1 mm
Cabinet Size	800 mm	800 mm
Surface	Polished	Polished

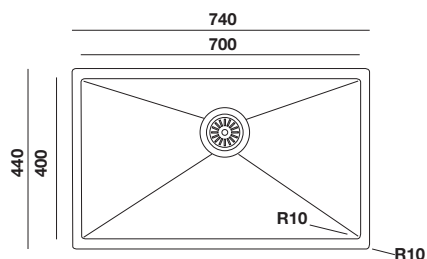
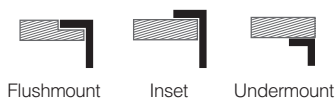
**H3104080R10**

Overall Size	850 x 450	850 x 450
Bowl Size	800 x 400	800 x 400
Sinks Depth	203	254
Thickness	1 mm	1 mm
Cabinet Size	900 mm	900 mm
Surface	Polished	Polished

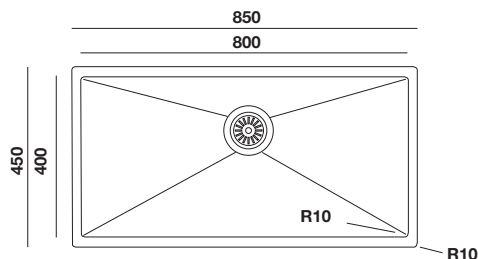





### H3105050R10



Flushmount    Inset    Undermount

Overall Size	540 x 540	540 x 540
Bowl Size	500 x 500	500 x 500
Sinks Depth	203	254
Thickness	1 mm	1 mm
Cabinet Size	650 mm	650 mm
Surface	Polished	Polished

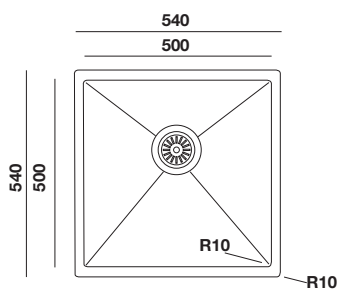

### H3105060R10



Flushmount    Inset    Undermount

Overall Size	640 x 540	640 x 540
Bowl Size	600 x 500	600 x 500
Sinks Depth	203	254
Thickness	1 mm	1 mm
Cabinet Size	650 mm	650 mm
Surface	Polished	Polished

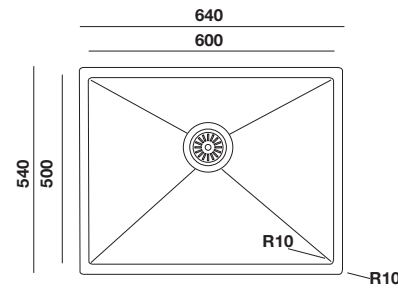

# New **R10** Series

# CRUX KROMEVEYE

**H3105070R10**

Overall Size	740 x 540	740 x 540
Bowl Size	700 x 500	700 x 500
Sinks Depth	203	254
Thickness	1 mm	1 mm
Cabinet Size	800 mm	800 mm
Surface	Polished	Polished

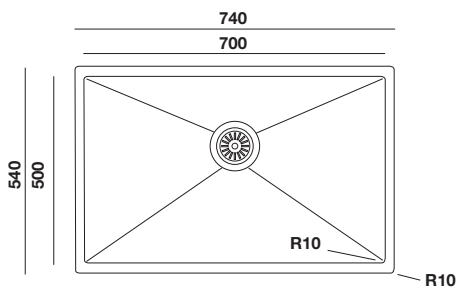
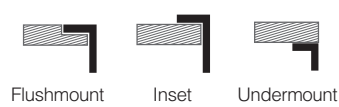
**H3105080R10**

Overall Size	840 x 540	840 x 540
Bowl Size	800 x 500	800 x 500
Sinks Depth	203	254
Thickness	1 mm	1 mm
Cabinet Size	900 mm	900 mm
Surface	Polished	Polished

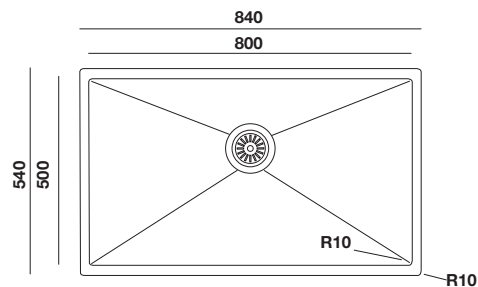





### H3105090R10



Flushmount    Inset    Undermount

Overall Size	940 x 540	940 x 540
Bowl Size	900 x 500	900 x 500
Sinks Depth	203	254
Thickness	1 mm	1 mm
Cabinet Size	1000 mm	1000 mm
Surface	Polished	Polished

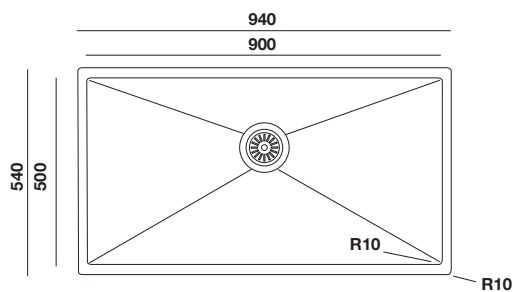

### H3104053R00D

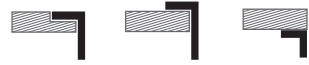

Flushmount    Inset    Undermount

Overall Size	565 x 435	565 x 435
Bowl Size	340 x 400	340 x 400
Sinks Depth	170 x 400	170 x 400
Thickness	203 / 140	254 / 140
Surface	1 mm	1 mm
Cabinet Size	600 mm	600 mm
Surface	Polished	Polished

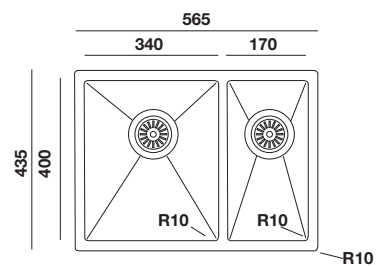

# New Series

# R10

# CRUX

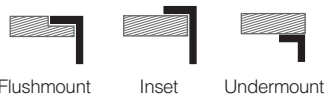
**H3104065R10D**

Overall Size	692 x 450	692 x 450
Bowl Size	380 x 400	380 x 400
	230 x 400	230 x 400
Sinks Depth	203 / 140	254 / 140
Thickness	1 mm	1 mm
Cabinet Size	700 mm	700 mm
Surface	Polished	Polished

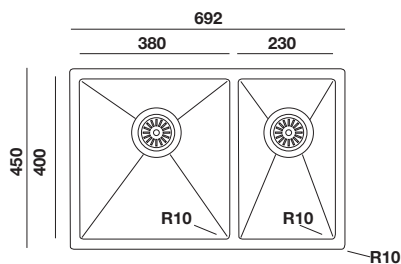
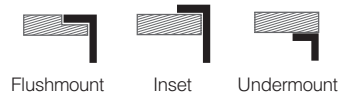
**H3104070R10D**

Overall Size	740 x 440	740 x 440
Bowl Size	340 x 400	340 x 400
	340 x 400	340 x 400
Sinks Depth	203 / 203	254 / 203
Thickness	1 mm	1 mm
Cabinet Size	800 mm	800 mm
Surface	Polished	Polished

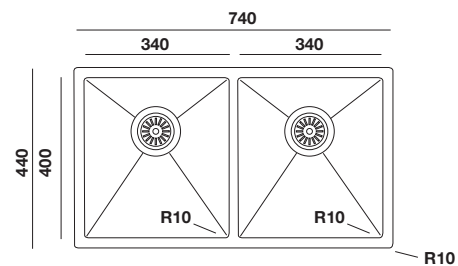





### H3104040R10BT



Flushmount      Inset

Overall Size	440 x 500	440 x 500
Bowl Size	400 x 400	400 x 400
Sinks Depth	203	254
Thickness	1 mm	1 mm
Cabinet Size	450 mm	450 mm
Surface	Polished	Polished

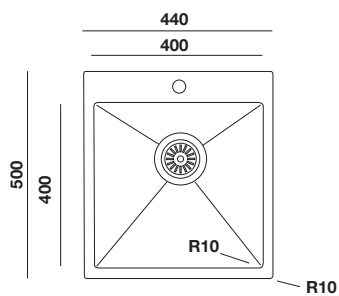

### H3104040R10KBT



Flushmount      Inset

Overall Size	450 x 505	450 x 505
Bowl Size	400 x 400	400 x 400
Sinks Depth	203	203
Thickness	1 mm	1 mm
Cabinet Size	470 mm	470 mm
Surface	Polished	Polished

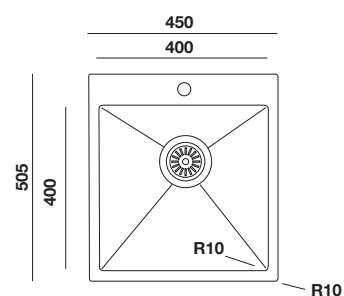

# New Series

# CRUX

**H3104045R10BT**

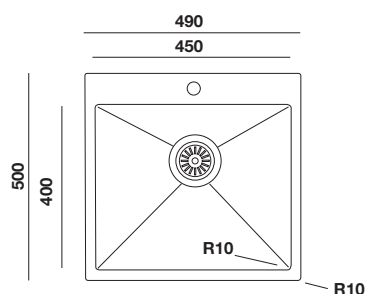

Flushmount    Inset

Overall Size	490 x 500	490 x 500
Bowl Size	450 x 400	450 x 400
Sinks Depth	203	254
Thickness	1 mm	1 mm
Cabinet Size	550 mm	550 mm
Surface	Polished	Polished

**H3104050R10BT**

Flushmount    Inset

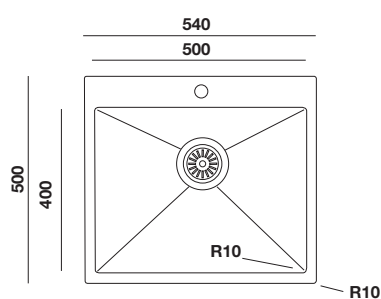
Overall Size	540 x 500	540 x 500
Bowl Size	500 x 400	500 x 400
Sinks Depth	203	254
Thickness	1 mm	1 mm
Cabinet Size	600 mm	600 mm
Surface	Polished	Polished







### H3104050R10KBT



Flushmount    Inset

Overall Size 550 x 505  
 Bowl Size 500 x 400  
 Sinks Depth 203  
 Thickness 1 mm  
 Cabinet Size 600 mm  
 Surface Polished

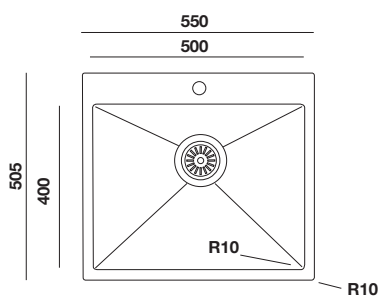

### H3104071R10KBT



Flushmount    Inset

Overall Size 760 x 505  
 Bowl Size 710 x 400  
 Sinks Depth 203  
 Thickness 1 mm  
 Cabinet Size 800 mm  
 Surface Polished

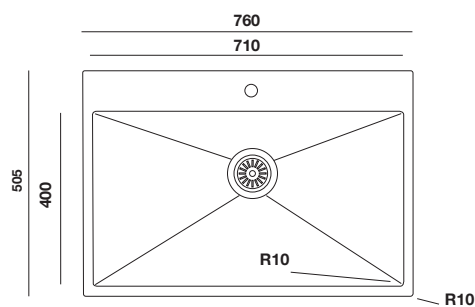

# New Series **R10**

# CRUX KROMEVEYE

**H3105050R10BT**

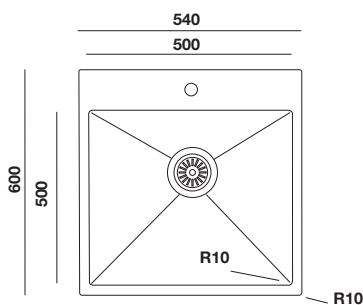

Flushmount      Inset

Overall Size	540 x 600	540 x 600
Bowl Size	500 x 500	500 x 500
Sinks Depth	203	254
Thickness	1 mm	1 mm
Cabinet Size	600 mm	600 mm
Surface	Polished	Polished

**H3105060R10BT**

Flushmount      Inset

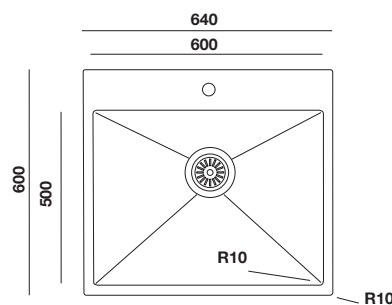
Overall Size	540 x 600	540 x 600
Bowl Size	500 x 500	500 x 500
Sinks Depth	203	254
Thickness	1 mm	1 mm
Cabinet Size	600 mm	600 mm
Surface	Polished	Polished





## H3105070R10BT



Flushmount    Inset

Overall Size	740 x 600	740 x 600
Bowl Size	700 x 500	700 x 500
Sinks Depth	203	254
Thickness	1 mm	1 mm
Cabinet Size	800 mm	800 mm
Surface	Polished	Polished

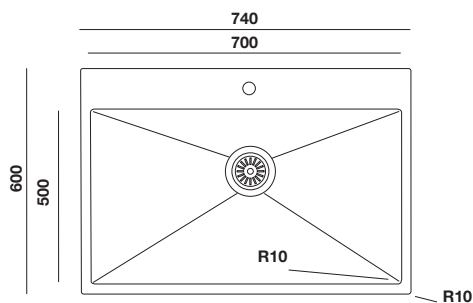

## H3105186R10D

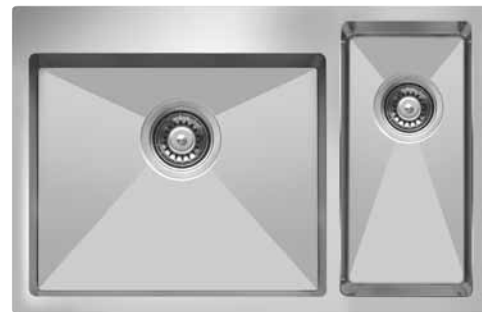

Flushmount    Inset

Overall Size	860 x 510	860 x 510
Bowl Size	540 x 410	540 x 410
Sinks Depth	270 x 480	270 x 480
Thickness	203 / 203	254 / 203
Thickness	1 mm	1 mm
Cabinet Size	900 mm	900 mm
Surface	Polished	Polished

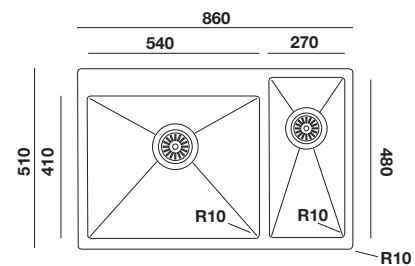





New Series

CRU







## H3103440R00



Flushmount    Inset    Undermount

Overall Size	380 x 440	380 x 440
Bowl Size	340 x 400	340 x 400
Sinks Depth	203	254
Thickness	1 mm	1 mm
Cabinet Size	400 mm	400 mm
Surface	Polished	Polished

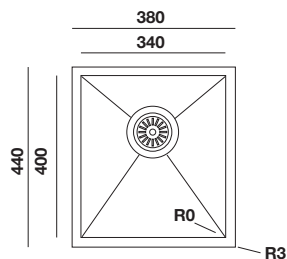

## H3103840R00

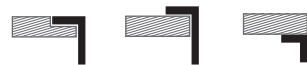

Flushmount    Inset    Undermount

Overall Size	420 x 440	420 x 440
Bowl Size	380 x 400	380 x 400
Sinks Depth	203	254
Thickness	1 mm	1 mm
Cabinet Size	400 mm	400 mm
Surface	Polished	Polished

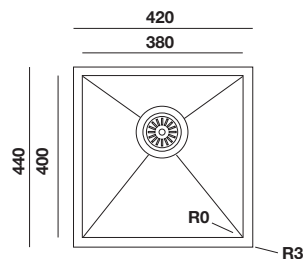

# New Series

# CRUX

**H3104040R00**

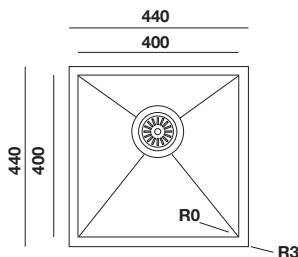

Flushmount    Inset    Undermount

Overall Size	440 x 440	440 x 440
Bowl Size	400 x 400	400 x 400
Sinks Depth	203	254
Thickness	1 mm	1 mm
Cabinet Size	450 mm	450 mm
Surface	Polished	Polished

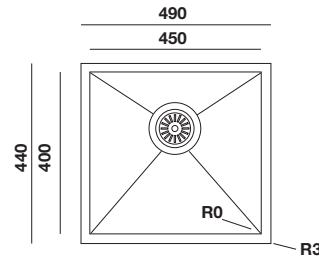

**H3104045R00**

Flushmount    Inset    Undermount

Overall Size	490 x 440	490 x 440
Bowl Size	450 x 400	450 x 400
Sinks Depth	203	254
Thickness	1 mm	1 mm
Cabinet Size	500 mm	500 mm
Surface	Polished	Polished



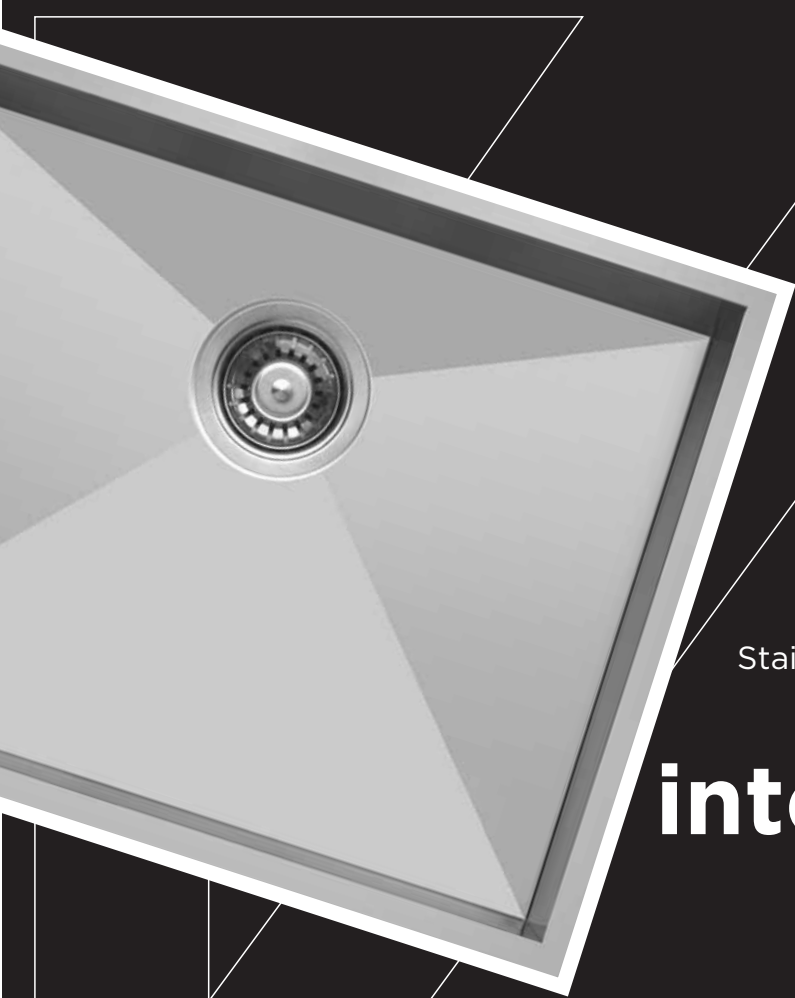



In history all began with an interaction.  
Stainless steel was formed by the interaction of  
Iron and Chromium,

# interaction is the beginning

## H3104050R00



Overall Size	540 x 440	540 x 440
Bowl Size	500 x 400	500 x 400
Sinks Depth	203	254
Thickness	1 mm	1 mm
Cabinet Size	600 mm	600 mm
Surface	Polished	Polished

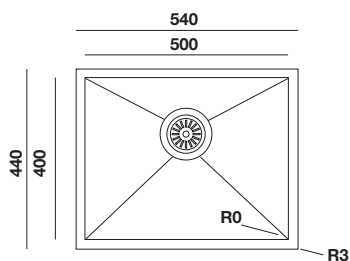

## H3104060R00

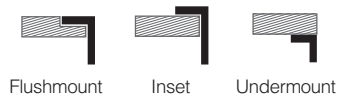

Overall Size	640 x 440	640 x 440
Bowl Size	600 x 400	600 x 400
Sinks Depth	203	254
Thickness	1 mm	1 mm
Cabinet Size	700 mm	700 mm
Surface	Polished	Polished

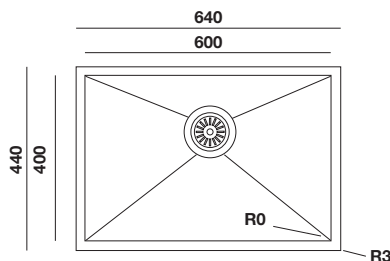

# New Series

# CRUX

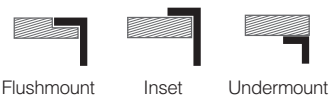
**H3104070R00**

Overall Size	740 x 440	740 x 440
Bowl Size	700 x 400	700 x 400
Sinks Depth	203	254
Thickness	1 mm	1 mm
Cabinet Size	750 mm	750 mm
Surface	Polished	Polished

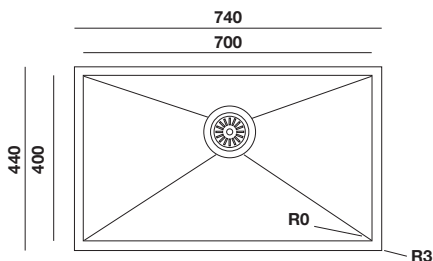
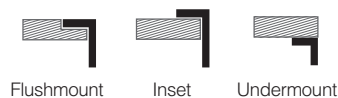

**H3104074R00**

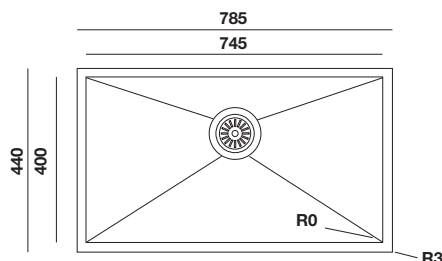
Overall Size	785 x 440	785 x 440
Bowl Size	745 x 400	745 x 400
Sinks Depth	203	254
Thickness	1 mm	1 mm
Cabinet Size	800 mm	800 mm
Surface	Polished	Polished



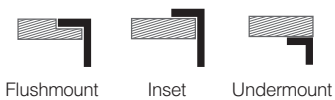

### H3105050R00



Overall Size	540 x 540	540 x 540
Bowl Size	500 x 500	500 x 500
Sinks Depth	203	254
Thickness	1 mm	1 mm
Cabinet Size	650 mm	650 mm
Surface	Polished	Polished

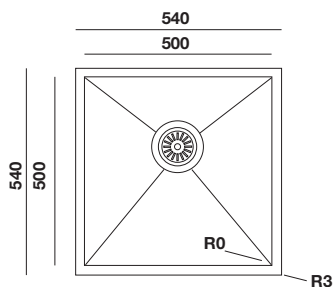

### H3105060R00



Overall Size	640 x 540	640 x 540
Bowl Size	600 x 500	600 x 500
Sinks Depth	203	254
Thickness	1 mm	1 mm
Cabinet Size	650 mm	650 mm
Surface	Polished	Polished

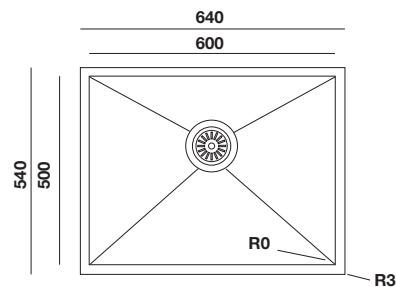



# New **R** Series

# CRUX **X**

**H3105070R00**

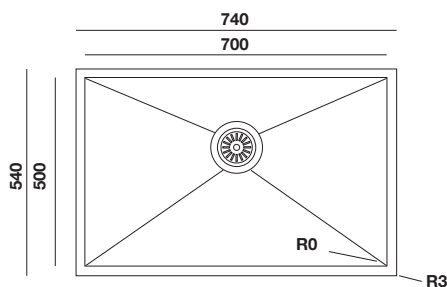

Flushmount    Inset    Undermount

Overall Size	740 x 540	740 x 540
Bowl Size	700 x 500	700 x 500
Sinks Depth	203	254
Thickness	1 mm	1 mm
Cabinet Size	800 mm	800 mm
Surface	Polished	Polished

**H3105080R00**

Flushmount    Inset    Undermount

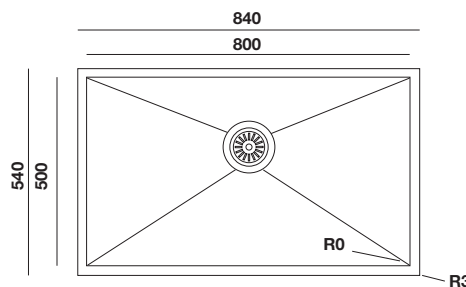
Overall Size	840 x 540	840 x 540
Bowl Size	800 x 500	800 x 500
Sinks Depth	203	254
Thickness	1 mm	1 mm
Cabinet Size	900 mm	900 mm
Surface	Polished	Polished





### H3105090R00



Overall Size	940 x 540	940 x 540
Bowl Size	900 x 500	900 x 500
Sinks Depth	203	254
Thickness	1 mm	1 mm
Cabinet Size	1000 mm	1000 mm
Surface	Polished	Polished

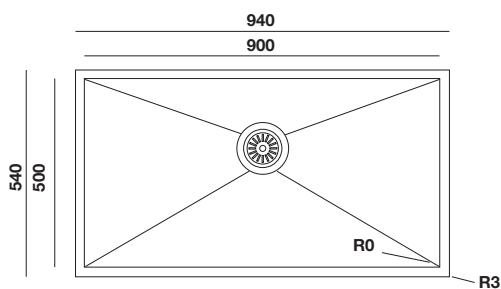

### H3104052R00D

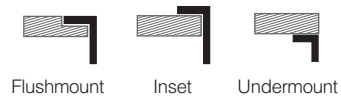

Overall Size	560 x 440	560 x 440
Bowl Size	340 x 400	340 x 400
	160 x 400	160 x 400
Sinks Depth	203 / 140	254 / 140
Thickness	1 mm	1 mm
Cabinet Size	600 mm	600 mm
Surface	Polished	Polished

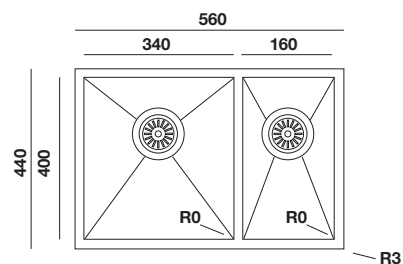

# New Series

# CRUX

## H3104053R00D



Flushmount    Inset    Undermount

Overall Size	570 x 440	570 x 440
Bowl Size	340 x 400	340 x 400
	170 x 400	170 x 400
Sinks Depth	203 / 140	254 / 140
Thickness	1 mm	1 mm
Cabinet Size	600 mm	600 mm
Surface	Polished	Polished

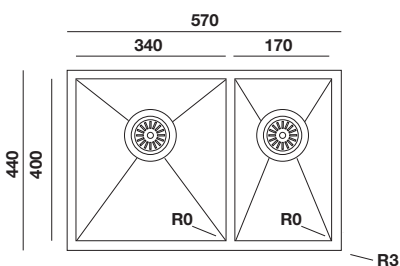

## H3104065R00D



Flushmount    Inset    Undermount

Overall Size	670 x 440	670 x 440
Bowl Size	380 x 400	380 x 400
	230 x 400	230 x 400
Sinks Depth	203 / 140	254 / 140
Thickness	1 mm	1 mm
Cabinet Size	700 mm	700 mm
Surface	Polished	Polished

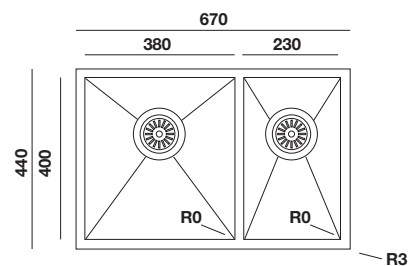





### H3104070R00D

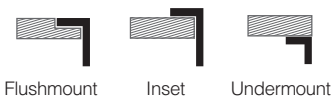

Overall Size	740 x 440	740 x 440
Bowl Size	340 x 400	340 x 400
	340 x 400	340 x 400
Sinks Depth	203 / 140	254 / 140
Thickness	1 mm	1 mm
Cabinet Size	800 mm	800 mm
Surface	Polished	Polished

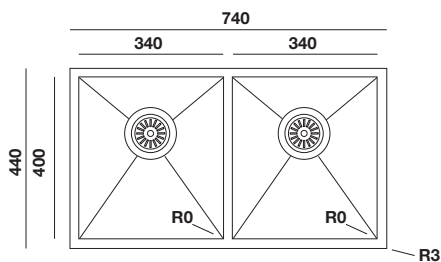

### H3104040R00BT



Overall Size	440 x 500	440 x 500
Bowl Size	400 x 400	400 x 400
Sinks Depth	203	254
Thickness	1 mm	1 mm
Cabinet Size	450 mm	450 mm
Surface	Polished	Polished

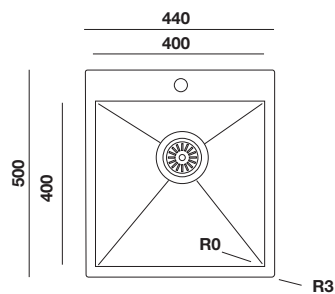

# New Series

# CRUX

**H3104045R00BT**

Overall Size	490 x 500	490 x 500
Bowl Size	450 x 400	450 x 400
Sinks Depth	203	254
Thickness	1 mm	1 mm
Cabinet Size	550 mm	550 mm
Surface	Polished	Polished

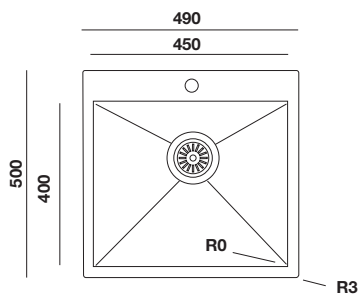
**H3104050R00BT**

Overall Size	540 x 500	540 x 500
Bowl Size	500 x 400	500 x 400
Sinks Depth	203	254
Thickness	1 mm	1 mm
Cabinet Size	600 mm	600 mm
Surface	Polished	Polished

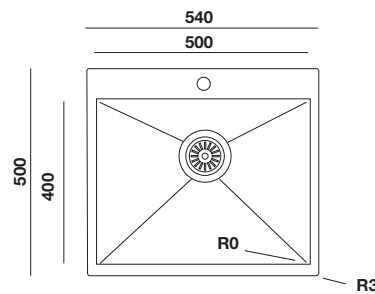



### H3105050R00BT



Flushmount Inset

Overall Size	540 x 600	540 x 600
Bowl Size	500 x 500	500 x 500
Sinks Depth	203	254
Thickness	1 mm	1 mm
Cabinet Size	600 mm	600 mm
Surface	Polished	Polished

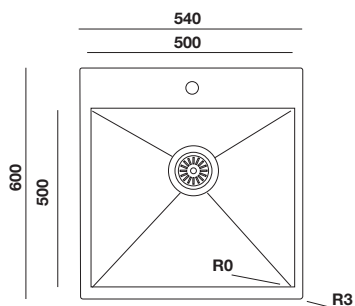

### H3105060R00BT



Flushmount Inset

Overall Size	640 x 600	640 x 600
Bowl Size	600 x 500	600 x 500
Sinks Depth	203	254
Thickness	1 mm	1 mm
Cabinet Size	650 mm	650 mm
Surface	Polished	Polished

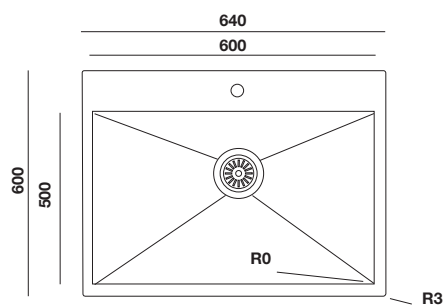



# New Series

# CRUX

**H3105070R00BT**

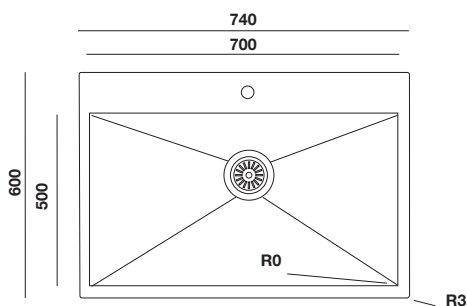

Flushmount      Inset

Overall Size	740 x 600	740 x 600
Bowl Size	700 x 500	700 x 500
Sinks Depth	203	254
Thickness	1 mm	1 mm
Cabinet Size	800 mm	800 mm
Surface	Polished	Polished

**H3105186R00D**

Flushmount      Inset

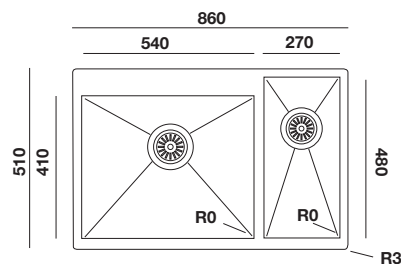
Overall Size	860 x 510	860 x 510
Bowl Size	540 x 410	540 x 410
	270 x 480	270 x 480
Sinks Depth	203 / 203	254 / 254
Thickness	1 mm	1 mm
Cabinet Size	900 mm	900 mm
Surface	Polished	Polished





**KROMEVEYE**

**S-617**  
ZEN



PRO KITCHEN FAUCET  
W.Outlet for  
FILTERED WATER SWIVEL  
SPOUT

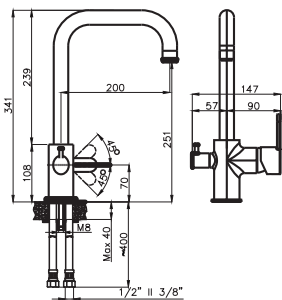

**S-618**  
FLUX



KITCHEN FAUCET WITH  
MAGNET TECHNOLOGY

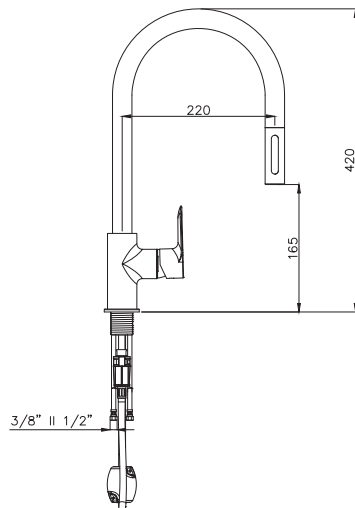

**S-619**  
AQUA



PULL OUT KITCHEN MIXER  
MAGNET TECHNOLOGY  
CHROME PLATED

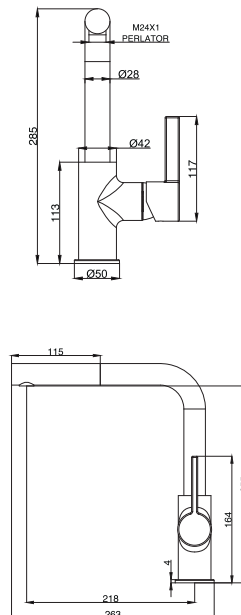

**S-620**  
PURE



PULL OUT KITCHEN MIXER  
CHROME PLATED

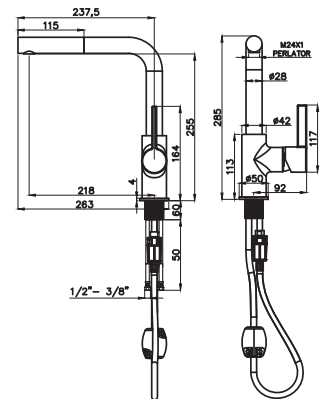





# ACCESSORIES



**S-818**

Telescopic Bridge



**S-820**

Small Stainless Steel Colander



**S-822**

Wooden Chopping Board



**S-819**

Telescopic Colander



**S-821**

Large Stainless Steel Colander



**S-823**

Large Chopping Board



**S-827**

Plastic Colander



**S-826**

Roller Mat (200mm)



**S-824**

Small Chopping Board



**S-828**

Plastic Bowl



**S-825**

Roller Mat (300mm)

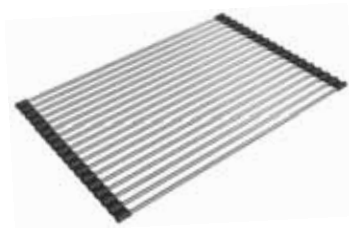

**S-701**

Strainer



**S-809**

Soap Dispenser



**S-830**

Dish Grids

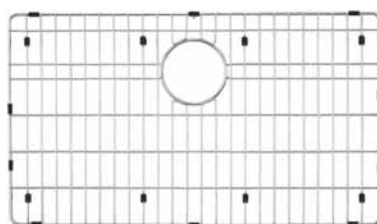

ø 90 mm  
single waste  
strainer with  
overflow





Akçaburgaz Mahallesi  
117. Sokak No:19 34522  
Esenyurt - İstanbul - TÜRKİYE

Tel: +90 (212) 886 55 88 (pbx)

e-mail: [info@kromeveye.com.tr](mailto:info@kromeveye.com.tr)  
[www.kromeveye.com.tr](http://www.kromeveye.com.tr)